

**THANK YOU**  
for purchasing...

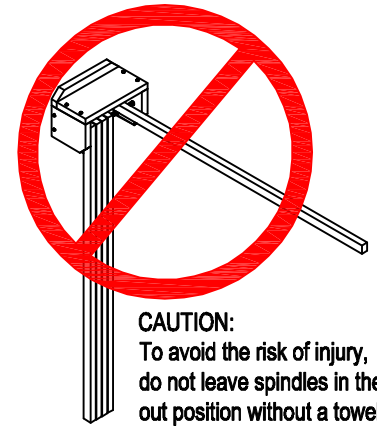

**CAUTION:**  
To avoid the risk of injury,  
do not leave spindles in the  
out position without a towel.

**Parts/Hardware:**

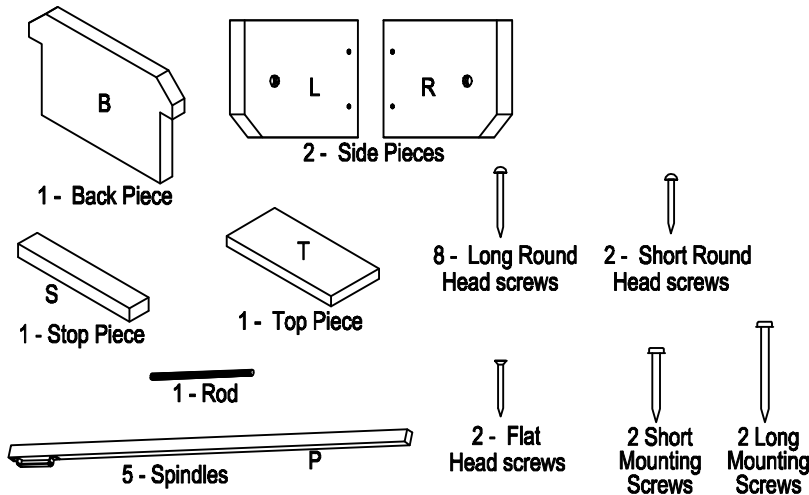

**Mounting Instructions:**

- Anchors for mounting to brick or cinder block structure not included
- Unit must be mounted to wall studs, fence posts or rails, or other solid structure. Do not mount to drywall surface with drywall anchors.
- Use Short Mounting screws for mounting directly to support
- Use Long Mounting screws for mounting to support through wall

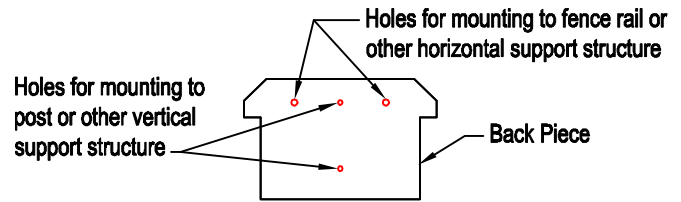

**Assembly Instructions:**

**Tools Required: Phillips Head Screwdriver**

1. Attach left side (L) to back (B) with 2 Long Round Head screws.

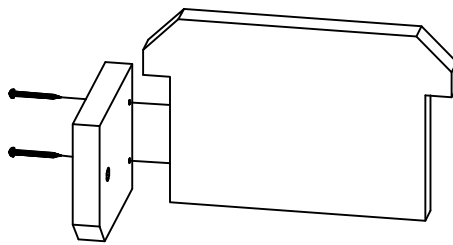

4. Insert rod into left side (L).

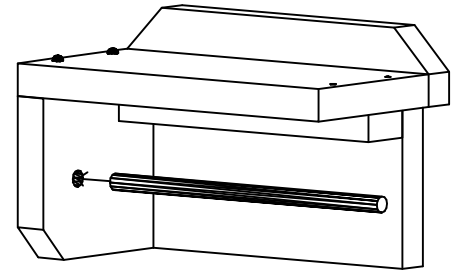

- 2a. Attach top (T) to left side (L) with 2 Long Round Head screws.

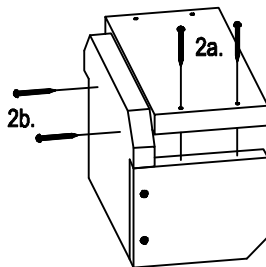

- 2b. Attach top (T) to back (B) with 2 Short Round Head screws.

5. Slide spindles (P) onto rod (R) with bracket facing rear of unit.

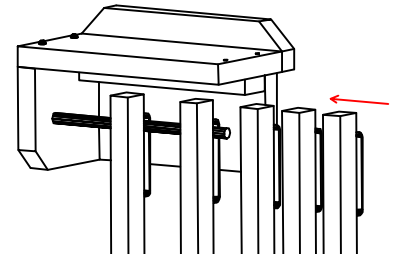

3. Attach stop (S) to underside of top (T) with 2 Flat Head screws.

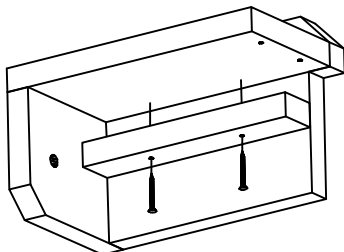

- 6a. Press right side (R) onto rod and attach to back (B) with 2 Long Round Head screws.

- 6b. Attach right side (R) to top (T) with 2 Long Round Head screws.

